

Instruction Manual

Hitachi Refrigerator

No frost

For household use only

Model

R-V660PRU7	R-V610PRU7	R-V540PRU7
R-V660PRU7-1	R-V610PRU7-1	R-V540PRU7-1
R-V661PRU0	R-V611PRU0	R-V541PRU0

INVERTER
X
Dual Fan Cooling



Thank you very much for purchasing the Hitachi refrigerator. Before using this please read the instruction manual carefully for the correct usage.

Maintenance work must only be carried out at workshop by well-trained maintenance worker.

HITACHI

Inspire the Next

Contents Page

Preparation for use

Warnings and Caution for Safety	2
Preparations before Use	5
■ Installation	5
■ Before Use	5
■ Optimal Food Storage	5

Operation

Location of Food Storage	5
How to use Control Panel	7
■ Name and Functions of Display .	7
■ Temperature Control	7
■ Other Functions	7
- Quick Freezing	8
- Energy Saving	8
- Lock	8
- Door Alarm and ECO Alarm Functions	8
■ Freezer Compartment	8
■ Refrigerator Compartment	9

Maintenance

■ Cleaning	9
Troubleshooting	10

HITACHI REFRIGERATORS DISCLAIMER / WARNING.....	12
--	----

R600a
Refrigerant

 **ECO**
THERMO-SENSOR

 **Nano Titanium**

Warnings and Caution for Safety

To avoid harm to the user, other persons or damage to property, please read and follow the warnings and cautions below and those given throughout this manual.

The following warnings and cautions are categorized by the level of possible harm or damage that may occur from ignoring directions.

The symbols are shown as below clearly showing the significance of directions.

	WARNING	This pictograph indicates "There is a high possibility of serious injury or death, if ignored".
	CAUTION	This pictograph indicates "There is a high possibility of injury or damage to property, if ignored".

The symbols below are examples.

	This symbol is an alert mark.
	This symbol indicates "prohibited".
	This symbol indicates "necessary".

- This refrigerator uses flammable refrigerants.
- The symbol column below states the precautions on flammable refrigerants.

R600a

This symbol denotes the precautions on flammable refrigerants.

WARNING

When you install ... To avoid fire, electric shock, and injury .

- Do not install the refrigerator in a place where it may come in contact with water.
- Do not install the refrigerator in a place exposed to rain.
- This may impair electricity insulation and cause electric shock of fire.

- Ground this refrigerator to prevent electric shock and noise interference. Always ground this refrigerator and install earth leakage circuit breaker when using it in places with high humidity or moisture. (Please consult with a retailer or Hitachi Service center.)

Power Cord and Power Plug ...To avoid fire, electric shock .

- Do not connect the wall outlet whose power capacity is less than the refrigerator's. Also, do not use power sources that are not a rated voltage.
- If a power source is shared with other appliances using double or multipoint adapters, the adapter may heat up beyond the normal level and cause fire.

- Connect the power plug firmly to a power outlet with the cord running down.
- Connection of the power plug with the cord running up could apply stress on the cord and cause electrical short or overheat, which could result in electrical shock or fire.
- Incomplete connection of the power plug could result in electrical shock or fire due to heat.

- Do not use the damaged or loose power plug or power outlet. This may cause fire or electric shock.

- If the supply cord is damaged, it must be replaced by the manufacturer, its service agent or similarly qualified persons in order to avoid a hazard.

- Do not cut, bend, fold the power cord to avoid fire and electric shock.

- Clean the dust on the power plug frequently with dry cloth.
- Unplug the power plug and wipe it with dry cloth.
- An insulation failure due to moisture or when dust sticks on the power plug, may cause fire.

- Do not insert or remove the power plug with wet hands.

- Be sure to unplug the power plug before maintaining the refrigerator.
- Be sure to hold the power plug to unplug.

During daily use ...To avoid fire, electric shock .

- Do not splash water on or inside the refrigerator.
- This may impair electricity insulation causing electric shock or fire.
- This may also cause gas leakage because of pipe rust.

- Do not disassemble, repair, or modify your refrigerator by yourselves.
- Please consult with a retailer if any repair is required.

- Do not use electrical appliances inside the food storage compartments of the appliance, unless they are of the type recommended by the manufacturer.

- Do not use mechanical devices or other means to accelerate the defrosting process, other than those recommended by the manufacturer.

- This appliance is not intended for use by persons (including children) with reduced physical, sensory or mental capabilities, or lack of experience and knowledge, unless they have been given supervision or instruction concerning use of the appliance by a person responsible for their safety.

- Ether, liquid propane gas, solvent, etc. which volatile cannot be stored in this refrigerator.
- Do not store anything that are generate heat or fire spark inside the refrigerator.

- Do not hang on the doors or step up on the various compartments.
- Injury may be caused by the refrigerator tipping over or hands getting caught in door.
- Do not enter in the refrigerator.

- Do not put water containers or foreign articles on the top of the refrigerator.
- Opening and closing doors etc. may cause the articles on the top of the refrigerator falling down, resulting in injury.

- Do not damage the refrigerant circuit.
- If you happen to damage the refrigerant pipe, stay away from the refrigerator and avoid using fire and electrical appliances.

- Medicines, chemicals, research and experimental substances should not be stored in the refrigerator.
- Substances that require precise conditions for storage cannot be stored in a domestic refrigerator.

- And, open windows to ventilate and contact retailers or Hitachi Service center.

⚠ WARNING

During daily use ...To avoid fire, electric shock . (Continuance)

- ❌ Do not use the refrigerator in the atmosphere of flammable gas.
- Sparks from points of electrical contacts such as door switches may ignite a fire.

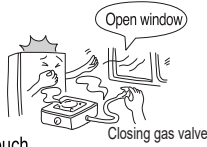

- ❌ In the event of a flammable gas leak, do not touch the refrigerator and open the windows for ventilation.

- ➡ If you find something wrong with the refrigerator, immediately unplug and consult with the retailers.



- ❗ Children should be supervised to ensure that they do not play with the appliance or get in.
- Children getting inside may not be able to get out.



- ❌ Children shall not play with the appliance.
- Cleaning and user maintenance shall not be made by children without supervision.

- ❗ Keep ventilation openings in the appliance enclosure or in the built-in structure, clear of obstruction.

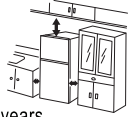

- ❗ This appliance can be used by children aged from 8 years and above and persons with reduced physical, sensory or mental capabilities or lack of experience and knowledge if they have been given supervision or instruction concerning use of the appliance in a safe way and understand the hazards involved.



When discarding the refrigerator.

- ❗ Follow the instructions of your region when discarding.
- This refrigerator uses R-600a for the refrigerant and cyclopentane for the blowing agent of the urethane heat insulation.

- ❗ When discarding the refrigerator, remove the door gaskets.
- To avoid a risk of an infant or child to be entrapped inside.

⚠ CAUTION

During daily use ...To avoid illness and injury .

- ❌ Do not put bottles, etc. forcibly in the door pockets.
- This may cause bottles dropping down or door pockets coming off.



- ❌ Do not store food which smells or food whose color is changed abnormal.
- Such an action may cause diseases.



- 🚫 Food and containers inside the freezer compartment should not be touched with wet hands.
- This may cause frost injury. (Especially in case of metal items.)



- ❌ Do not hold the top, bottom and side of the doors when closing them.
- This may result in your fingers caught by the door edge.



- ❌ Do not make an impact on the glass-made doors or shelves.
- They are made of tempered glass, however, an excess impact may result in breakage and is dangerous.



- ❌ Do not have food items protruding over the front edge of each shelf.
- Doors may not be closed properly or the door pockets may drop down. Injury may be caused from items like bottles falling and knocking over your feet.



- ❌ Do not store glass bottles in the freezer compartment.
- Bottles may break by the contents freezing and cause injury.

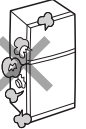

- ❌ Do not put your hands into the bottom surface of the refrigerator cabinet.
- When cleaning, putting your hands near the bottom surface of the refrigerator may result in injury by thin metal sheets.



- ❗ Do not have your feet too close when opening the door of the refrigerator.
- When opening the door, your feet may be hit, resulting in injury.



When moving or carrying ...To avoid damaging, wetting, soiling the floor, or to avoid injury.

- ❌ Do not use door handles when carrying the refrigerator.
- Never use the carrying handles to hang up with a chain hoist or similar machines.

- ❗ Use the carrying handle when carrying the refrigerator.
- Hold the carrying handles only. If hold door handles, hands may slip and may cause injury.
- Carry the refrigerator by at least 4 persons for safety reasons.
- Carry it with the doors facing upward.

- Before carrying the refrigerator:
 1. Take out all food items and ice cubes.
 2. Lay a protective sheet or cloth to protect the floor from damage and catch remaining water spilled from the refrigerator.
 3. With a large piece of old cloth underneath, tilt the refrigerator backward to drain water.
 4. Finally carry the refrigerator with the doors facing upward.
- Secure the doors well with adhesive tapes so they do not open.
- If transporting in a vehicle, do not load the refrigerator on its side. This could damage the compressor.

- ❌ On a floor that is easily scratched, do not move the refrigerator with the wheels of refrigerator.
- The wheels may scratch the floor.
- For a floor that may be easily scratched, lay a protective mat, etc. .

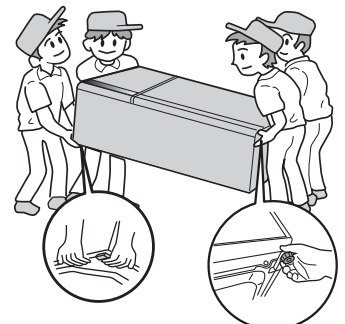
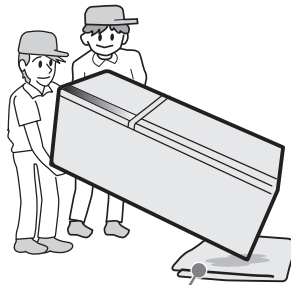







Such as old cloth

When replacing lamps (LED) is required.

- ❗ When replacing lamps (LED) is required. Please contact your dealer or Hitachi Service Center.

WARNING

-  ■ Clean regularly surfaces that can come in contact with food and accessible drainage systems.
-  ■ Two-star frozen-food compartments are suitable for storing pre-frozen food, storing or making icecream and making ice cubes.
-  ■ If the refrigerating appliance is left empty for long periods, switch off, defrost, clean, dry, and leave the door open to prevent mould developing within the appliance.
-  ■ Children aged from 3 to 8 years are allowed to load and unload refrigerating appliances.
-  ■ Opening the door for long periods can cause a significant increase of the temperature in the compartments of the appliance.
-  ■ Store raw meat and fish in suitable containers in the refrigerator, so that it is not in contact with or drip onto other food.
-  ■ One-, two- and three-star compartments are not suitable for the freezing of fresh food.

Preparations before Use

Installation

1. Install on a rigid and level floor.
2. Please use this refrigerator in a room temperature between 10°C to 43°C.
Sufficient performance may not be obtained, if the room temperature is too low or too high.
3. Do not install the refrigerator where it is exposed to direct sunlight or other heat source.
4. Install in an atmosphere which is dry or has air ventilation.
5. The refrigerator requires enough air ventilation space around the cabinet to have efficient cooling performance
Space of at least 30 cm over the top, 10 cm at rear and 5 cm at both sides for proper air circulation.
6. Ground the refrigerator to prevent electric shock and noise interference. Always ground this refrigerator when using it in places with high humidity or moisture (Please consult with retailers).
7. Make the refrigerator stand horizontally by adjusting the leveling legs (adjustor).
8. Place the front cover in the direction as figure and insert both into the holes until locked position.

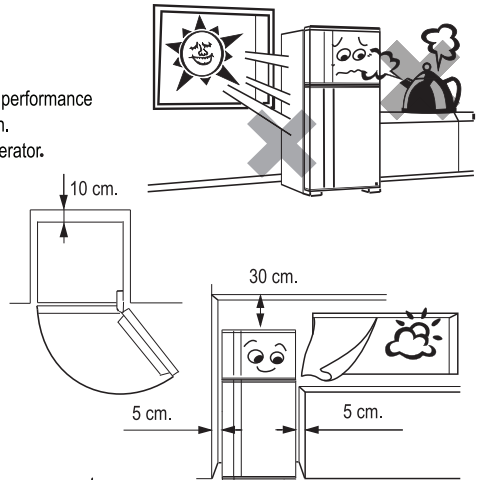
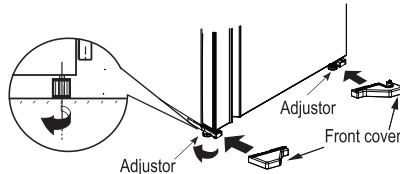
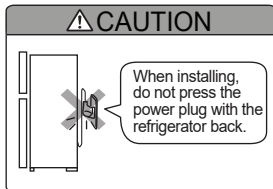

Before Use

1. After transporting : If Refrigerator has been kept in horizontal position for more than 10 minutes for transportation or any other reasons, it should stand upright for more than 1 hour before plugging it in.
2. Clean inside the refrigerator. Wipe the surface gently with soft cloth.
3. Connect the refrigerator to an exclusive wall power outlet. The refrigerator can be connected to an outlet soon after it is installed. Surely use with the rated voltage and exclusive power outlet.
4. Allow enough duration for sufficient cooling before storing food. It may take about 4 hours to fully cool down and could even take about 24 hours when the ambient temperature is high.

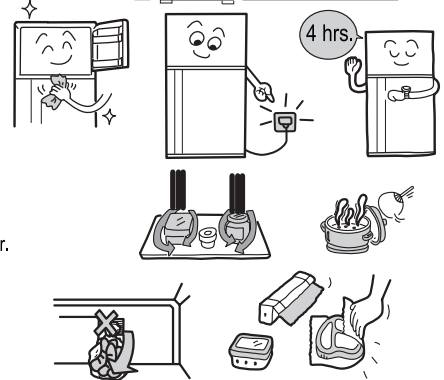

Optimal Food Storage

1. Keep enough space between food. Several food placed too close together may obstruct the flow of cold air.
2. Make food cool enough before putting it in the refrigerator. Putting warm food in the refrigerator raises the inside temperature and wastes electricity.
3. Do not block the cold air vent. This will adversely affect the cold air flow and may not keep the temperature inside even. Moreover, it could result in freezing food near the vent.
4. Using food wrap or sealed containers prevent the food from drying on transition of smells.

Location of Food Storage

R-V660PRU7, R-V660PRU7-1, R-V661PRUO

Freezer Compartment -20°C~-18°C

Freezer Shelves

- Storage of frozen food and ice cream, etc.



Movable Twist Ice Tray

- For ice cube storage made by "Twist Ice Maker" (See page 8)



Refrigerator Compartment 1°C~5°C

Refrigerator Shelves

- Storage of side dish, desert, etc.



Fresh select 1°C~5°C

Fresh select

- Storage of fruits vegetables or dairy meat, (see page 9)

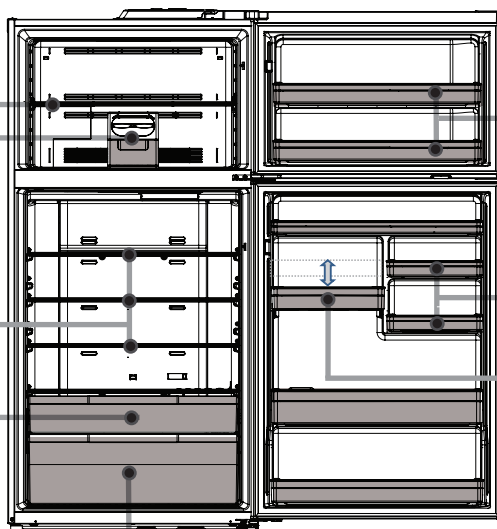

Freezer Door Pockets -19°C~-17°C

Freezer Door Pockets

- Storage of packed small frozen food.
- Not recommended for long storage, because temperature rise caused by door open may occur.



Refrigerator Door Pockets 2°C~6°C

Refrigerator Door Pockets

- Storage of packed small food and drinks such as juice, milk, etc.



Adjustable Door Pockets

- Lift up for storage 2 litres bottle at the lower pocket.



Vegetable Compartment 4°C~7°C

Vegetable Drawers

- Storage of fruits and vegetables.



Notice

- Above temperatures are the approximate values in the conditions of outside temperature 32°C, the setting of the refrigerator compartment "Normal", freezer compartment "Normal" while doors being closed and without food storage.
- Door pocket temperatures may be little higher than above temperatures.

Location of Food Storage

R-V610PRU7, R-V610PRU7-1, R-V611PRU0

Freezer Compartment -20°C~-18°C

Freezer Shelves

- Storage of frozen food and ice cream, etc.



Movable Twist Ice Tray

- For ice cube storage made by "Twist Ice Maker"

(See page 8)

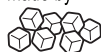

Refrigerator Compartment 1°C~5°C

Refrigerator Shelves

- Storage of side dish, desert, etc.



Fresh select 1°C~5°C

Fresh select

- Storage of fruits vegetables or dairy meat. (see page 9)

Freezer Door Pockets -19°C~-17°C

Freezer Door Pockets

- Storage of packed small frozen food.
- Not recommended for long storage, because temperature rise caused by door open may occur.



Refrigerator Door Pockets 2°C~6°C

Refrigerator Door Pockets

- Storage of packed small food and drinks such as juice, milk, etc.



Adjustable Door Pockets

- Lift up for storage 2 litres bottle at the lower pocket.



Vegetable Compartment 4°C~7°C

Vegetable Drawers

- Storage of fruits and vegetables.

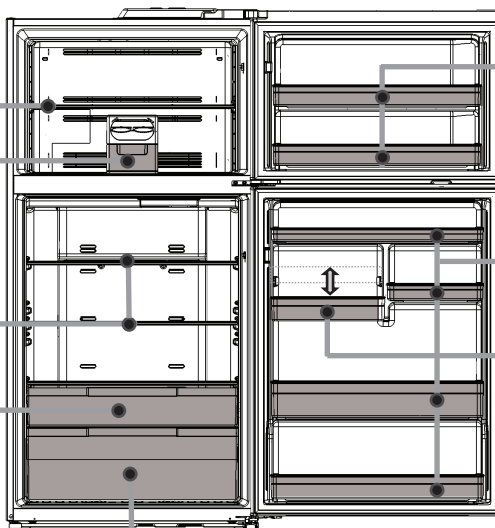

Notice

- Above temperatures are the approximate values in the conditions of outside temperature 32°C, the setting of the refrigerator compartment "Normal", freezer compartment "Normal" while doors being closed and without food storage.
- Door pocket temperatures may be little higher than above temperatures.

Location of Food Storage

R-V540PRU7, R-V540PRU7-1, R-V541PRU0

Freezer Compartment -20°C~-18°C

Freezer Shelves

- Storage of frozen food and ice cream, etc.



Movable Twist Ice Tray

- For ice cube storage made by "Twist Ice Maker"

(See page 8)

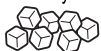

Refrigerator Compartment 1°C~5°C

Refrigerator Shelves

- Storage of side dish, desert, etc.



Fresh select 1°C~5°C

Fresh select

- Storage of fruits vegetables or dairy meat. (see page 9)

Freezer Door Pockets -19°C~-17°C

Freezer Door Pockets

- Storage of packed small frozen food.
- Not recommended for long storage, because temperature rise caused by door open may occur.



Refrigerator Door Pockets 2°C~6°C

Refrigerator Door Pockets

- Storage of packed small food and drinks such as juice, milk, etc.



Vegetable Compartment 4°C~7°C

Vegetable Drawers

- Storage of fruits and vegetables.

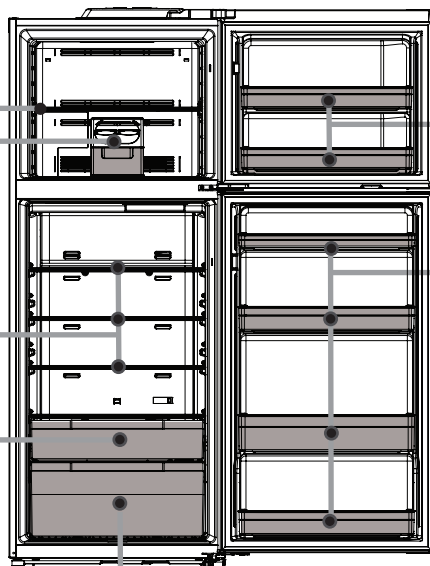

Notice

- Above temperatures are the approximate values in the conditions of outside temperature 32°C, the setting of the refrigerator compartment "Normal", freezer compartment "Normal" while doors being closed and without food storage.
- Door pocket temperatures may be little higher than above temperatures.

How to use Control Panel

□ Name and Functions of Display

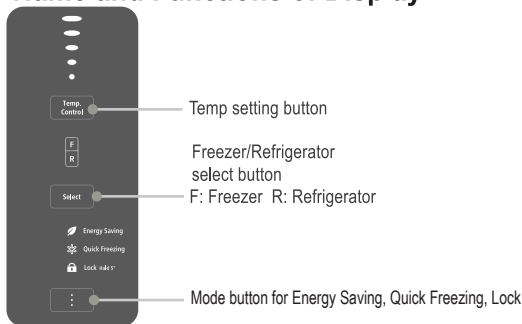

Notice

- If you unplug the power plug or a power failure occurs and then the refrigerator restarts, the temperature display and each setting will be automatically resumed ***. However, "Quick Freezing" operation will be cancelled.
- Approximately 30 seconds after the end of operation, all LED become unlit.
- Response of the touch panel may change depending on the surrounding temperature, humidity, physical condition of the user or operation status of the adjoining electric product.
- The panel may not respond if it is wet or dirty.

□ Temperature Control The display is indicating the status of temperature setting.

1. Freezer Compartment

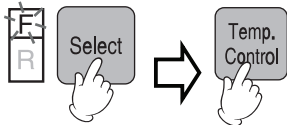

Touch "Select" button to select "F"
"F" lamp light is on.

Touch "Temp. Control" button to setting a temperature

2. Refrigerator Compartment

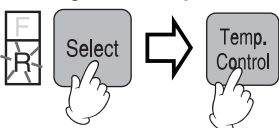

Touch "Select" button to select "R"
"R" light is on.

Touch "Temp. Control" button to setting a temperature

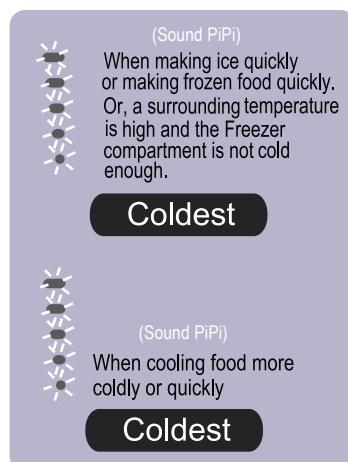
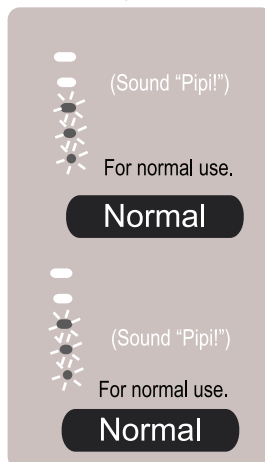
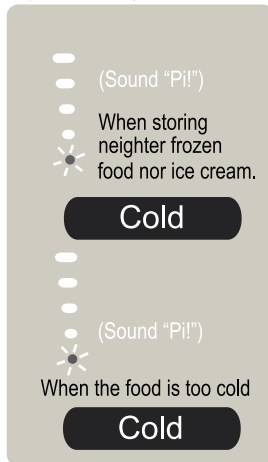

*** There must setting more than 45 seconds before unplug the power or power failure. otherwise the temperature display shown as before setted.

Other Function

□ To set the fine adjustment of the temperature (Refrigerator compartment/ Freezer Compartment)

Touch "Select" and "Temp control" to make as adjustment.

Each time you touch the button, the corresponding indicator lamp changes in order shown below (9 steps).

(■ Lighting ■ Blinking □ Turned off)

Indication lamp									
Setting	Cold	➔	➔	➔	Normal	➔	➔	➔	Coldest
Sound	Pi!	Pi!	Pi!	Pi!	PiPi!	Pi!	Pi!	Pi!	Pi!

□ To cancel the fine adjustment of the temperature.

Touch "Temp. Control" button for 5 seconds until "PiPi!" sound is heard and you can set temperature by normal step (5 steps)



Touch "Temp. Control" for 5 seconds until 1 "PiPi!" sound is heard.

Notice

- This function is subjected to change according model type.
- Factory setting, the adjustment temperature by normal step (5 steps).

Quick Freezing

When you want to freeze food or make ice quickly, use this function.

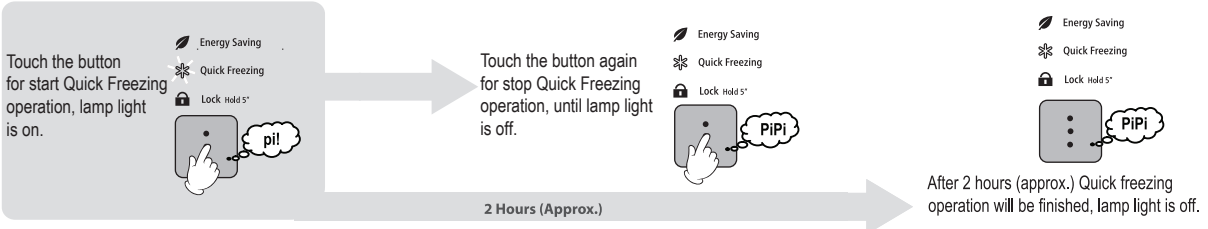

Notice • During "Quick Freezing", priority cooling of the freezer compartment will be done. Thus, try to avoid unnecessary opening and closing the doors not to have a temperature rise of the refrigerator compartment.

Energy Saving

Recommend to use this function in case of low storage volume, or a long vacation when the doors are not opened for long time.



Notice • In case the compartment temperature rises up, the operation will be back to a normal setting temporarily.
• After a long time operation of "Energy Saving", in some cases, fatty ice cream, etc. may become soft. Please stop "Energy Saving" operation in this case.

Lock

You can prevent mischief of all the buttons on the control panel caused by children.

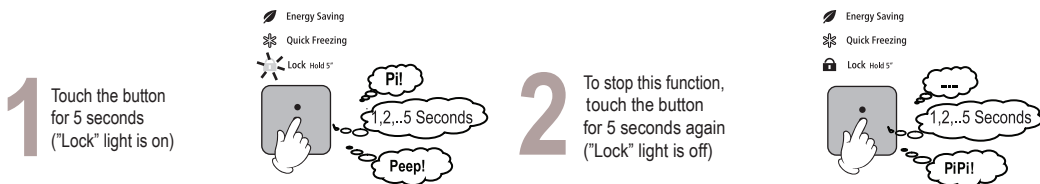

Door Alarm and ECO Alarm Functions

If the door is left open for more than 1 minute, the alarm system will inform the user by the sound and digital display.

- Door Alarm: Informs by PeepPeepPeep sound.
- Eco Alarm Display: Indicates the door opening state on the control panel.

Duration of Door Opening	Door Alarm Sound	ECO Alarm Display
After 1 minute	PeepPeepPeep	All LED on display - are Flashing
After 2 minute	PeepPeepPeepPeepPeep	
After 3 minute	Peeps continuously.	

To Deactivate Alarm and Sound

1. Keep Touching "Select" button for 5 seconds until "Peep!" sound is heard.

There is not sound when touching any button (disactive door alarm sound).



Notice • Upon shipment, the alarm and sound are set "ON".
• If the Door Alarm, Eco Alarm Display and each button operation sound have been deactivated, the refrigerator will still set the alarm and sound to "OFF" even though a power failure or when unplugging and reconnecting the power plug.

To re-activate Alarm and Sound

1. Keep Touching "Select" button for 5 seconds until "PIPI!" sound is heard.

There is sound when Touching any button (active door alarm sound).

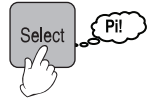
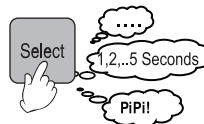

Freezer Compartment

Ice Making

- Pull out the "Twist Ice Maker" and pour in water up to the full line.
- After ice is made, turn the lever clockwise firmly and drop the ice into the "Ice Bank".

Notice

- Do not remove the ice maker with the frame and do not twist it as shown in the picture or else it will be damaged.
- Do not use the "Ice Bank" as an ice maker tray or else it will be damaged.

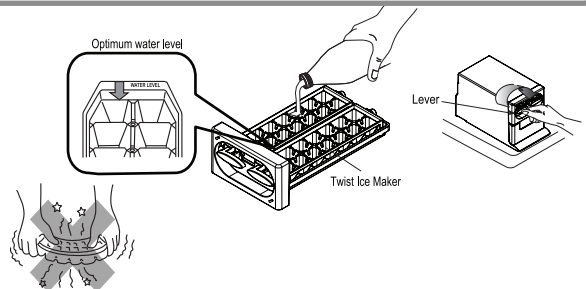

Refrigerator Compartment

- If you keep refrigerator in a hot and humid place, frequent opening the door or storing a lot of vegetables in it may cause dew forming which has no effect on its performance. Remove the dew with cloth free from care.

Fresh Select

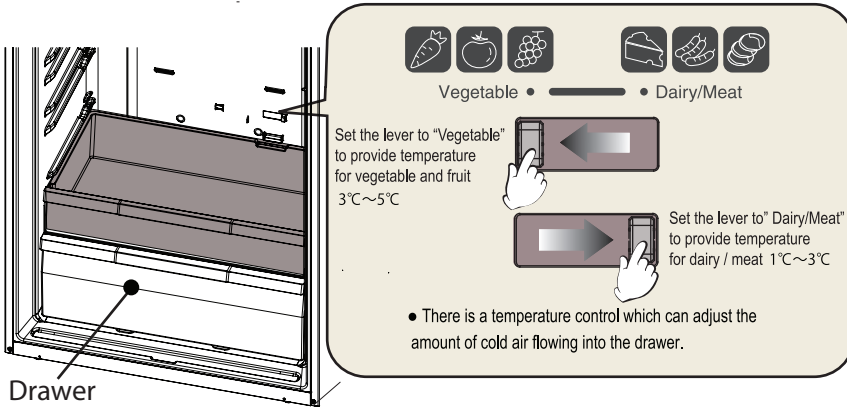

Caution

- If you want to store meat or fish longer, please store them in the freezer compartment.
- Be careful, it might be frozen if that food has a lot of moisture.
- When closing the refrigerator door, push the chilled case for close. If you close the door while the chilled case is still pulled out. The chilled case might be broken.
- Meat and fish can be kept fresh before being frozen.



CAUTION

The drawer is large enough space for children or pets to crawl DO NOT allow them to play inside the drawer.

Egg pocket

- It can place 14 eggs also turn the rear side to place the small items.

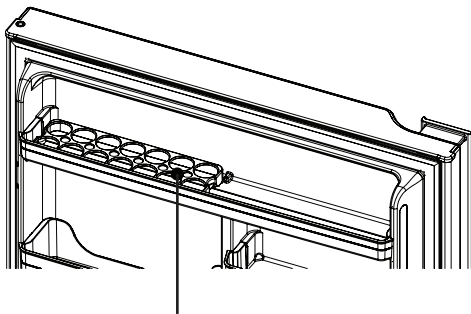

Egg Pocket

Adjusting the shelves.

- Pull up the back and pull out the shelf forward.
- Set the refrigerator shelves by combining with stored food.

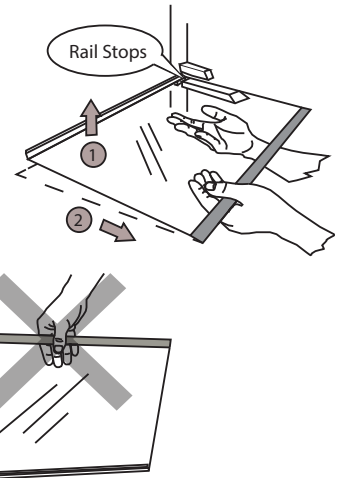
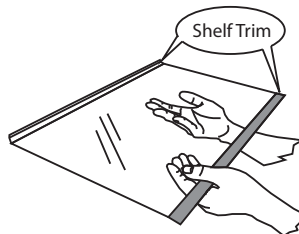

CAUTION

Shelf trims are removable, Holding the shelf with both hands. DO NOT holding trim or holding shelf with only one hand otherwise it may drop or injury.

Maintenance

Cleaning (Please clean the refrigerator once a month)

- Unplug the refrigerator.
- Remove all food.
- Wipe the refrigerator clean.
 - It is the best if smudges are wiped off immediately. It is also recommended to clean the areas of the refrigerator not clearly in view once a year.
 - Use a soft cloth moistened with lukewarm water to wipe of smudges. For smudges which are difficult to remove, use diluted neutral washing liquid.
 - Neatly clean the door gasket because it gets dirty easily.
- If any droplets remain on the surface of the parts that have been washed, wipe them.
- Return all part to their original locations.
- Inspect and clean the power plug, cord and outlet.
- Plug the power cord into the outlet.



Notice

- Even if the power plug is plugged in immediately after being unplugged, the compressor will not run for 10 minutes. However, if the inside is not cold, it will start running in approximately 30 seconds.

CAUTION

- Do not use the following items which damage parts and painting : Polishing powder, soap powder, oil, boiling water, brush, acid, benzene, thinner, alcohol and alkaline detergent, etc.
- If the cooking oil smears on the refrigerator, please wipe it off. (The plastic parts might be cracked).



CAUTION

When replacing lamps (LED) is required. Please contact your dealer or Hitachi Service Center.

Troubleshooting

Before you call for service, please check the following items:

The refrigerator does not get cold at all.	<ul style="list-style-type: none"> ● Is the refrigerator plugged in properly? ● Check the fuse box for blown fuse or tripped circuit breaker.
The refrigerator does not get cold enough.	<ul style="list-style-type: none"> ● Is the refrigerator placed in the direct sunlight? ● Is the temperature set to "Cold"? ● Is the food stored too much? ● Is the door being slightly opened ? ● Is the refrigerator placed near heat sources? ● Has anything hot been placed in the refrigerator? ● Is the door being opened and closed too frequently?
Food in the refrigerator compartment freezes.	<ul style="list-style-type: none"> ● Is the temperature set to "Coldest"? ● Do you place food with moisture or vegetables nearby the cold air vent? It will be frozen if it is placed nearby the cold air vent.
The inside is smelling.	<ul style="list-style-type: none"> ● Do you store food with odor without wrapping it?
The refrigerator is noisy.	<ul style="list-style-type: none"> ● Make sure the refrigerator is installed firmly. ● Is the refrigerator touching the wall?

The Control Panel does not respond:

The Control Panel does not respond:	<ul style="list-style-type: none"> ● Is "Child Lock" selected by using the lock function on the panel for operation? ● Is Refrigerator the compartment Door open? Operate after closing it. ● Are you wearing gloves or applying a plaster? Touch directly with your finger. ● Is there water or dirt on the Control Panel? ● Are you touching a next button? Touch only one button at a time
The Control Panel is unlit.	<ul style="list-style-type: none"> ● Approximately 30 seconds after the end of operation, Indicator LED become unlit.

This is not a malfunction of the refrigerator.

The surface of the refrigerator is hot.	<ul style="list-style-type: none"> ● The refrigerator is equipped with the dew prevention and heat radiation tubes. The back and side plates may be heated especially when starting up or if the door is frequently opened and closed.
If a door is shut, other doors may open.	<ul style="list-style-type: none"> ● The two compartments are connected with an air duct. When closing one of the doors, the door may be opened by the air pressure through the duct. This is a normal phenomenon.
Does the refrigerator make any abnormal noises (sound)?	<ul style="list-style-type: none"> ● The sound like water flowing and boiling water is the sound of the cooling liquid (refrigerant). ● A creaking sound comes from the storage compartment. It is the sound caused by friction of the parts due to temperature change.
There are waving and/or distortions on the door surface, the side and the top surface of the refrigerator.	<ul style="list-style-type: none"> ● Slight waving and/or distortions are generated in the manufacturing process of the refrigerator. They may be conspicuous according to the position of the light source and/or the brightness etc., but there is no problem with the performance.

Hitachi Europe Ltd.
Digital Media Group (DMG)
Whitebrook Park, Lower Cookham Road,
Maidenhead, Berkshire, SL6 8YA, United Kingdom
Contact email: tech.assist@hitachi-eu.com

About Non-fluorocarbon refrigerator.

- This refrigerator, including refrigerant and the heat insulator, is using hydrocarbon (non-fluorocarbon). The hydrocarbon is a material that does not rip up the ozone and have very little influence on global warming. It is the global environment concern material).
- R600a refrigerant is flammable. But the refrigerant is sealed up by the refrigerant circuit, and never leaks by usual use. In case of the refrigerant circuit being damaged by any chance, please avoid using fire or electric product, open the window and ventilate. Afterwards, please contact Hitachi Service Center.

Severe warning signs for Disposal

Cyclopentane is used as in the insulation. The gases in insulation material require a special disposal procedure.
Please contact your local authorities in regard to the environmentally safe disposal of this product.

Information for users in European Union Countries.

The mark shown on the right is in compliance with the Waste Electrical & Electronic Equipment directive 2012/19/EU (WEEE).
This Mark indicates the requirement NOT to dispose the equipment as unsorted municipal waste, but use the return and collection system available. Business users should contact their supplier and check the terms and conditions of the purchase contract.
This product and its electronic accessories should not be mixed with other commercial waste for disposal.



HITACHI REFRIGERATORS DISCLAIMER / WARNING

Some (simple) failures can be adequately handled by the end-user without any safety issue or unsafe use arising, provided that they are carried out within the limits and in accordance with the following instructions (see the “Self-Repair” section). Therefore, unless otherwise authorized in the “Self-Repair” section below, repairs shall be addressed to registered professional repairers in order to avoid safety issues. A registered professional repairer is a professional repairer that has been granted access to the instructions and spare parts list of this product by the manufacturer according to the methods described in legislative acts pursuant to Directive 2009/125/EC. However, only the service agent (i.e. authorized professional repairers) that you can reach through the phone number given in the user manual/warranty card or through your authorized dealer may provide service under the guarantee terms. Therefore, please be advised that repairs by professional repairers (who are not authorized by importer) shall void the guarantee.

Self-Repair

Self-repair can be done by the end-user regarding the following spare parts: door handles, doorHinges (as a part – not as an accessory), trays, baskets, and door gaskets. Moreover, to ensure product safety and to prevent risk of serious injury, the mentioned self-repair shall be done following the instructions in the user manual for self-repair.

For your safety, unplug the product before attempting any self-repair.

Repair and repair attempts by end-users for parts not included above and/or not following the instructions in the user manuals for self-repair, might give raise to safety issues not attributable to the importer, and will void the warranty of the product. Therefore, it is highly recommended that end users refrain from the attempt to carry out repairs falling outside the mentioned list of spare parts, contacting in such cases authorized professional repairers or registered professional repairers. On the contrary, such attempts by end-users may cause safety issues and damage the product and subsequently cause fire, flood, electrocution, and serious personal injury to occur.

The manufacturer/seller cannot be held liable in any case where end-users do not comply with the above.

The spare part availability of the Hitachi refrigerator that you purchased is 7 years, especially for door gaskets this is expanded to 10 years. During this period, original spare parts will be available to operate the refrigerator properly.